

MODEL IFMA - DIN-RAIL FREQUENCY TO ANALOG CONVERTER

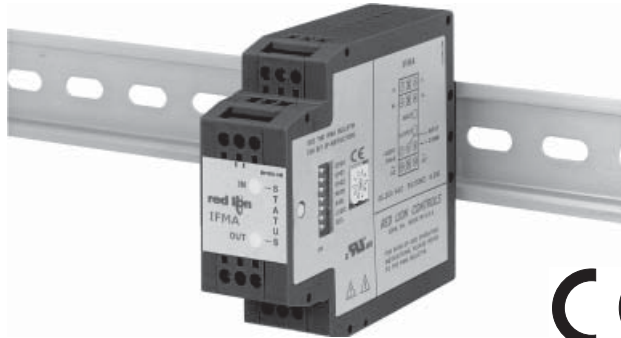

- SIMPLE ON-LINE RANGE SETTING
(Using Actual Input Signal or Signal Generator)
- USER SETTABLE FULL SCALE FREQUENCY FROM 1 Hz to 25 KHz
- FOUR OUTPUT OPERATING RANGES
(0 to 5 V, 0 to 10 V, 0 to 20 mA, and 4 to 20 mA)
- PROGRAMMABLE INPUT CIRCUIT ACCEPTS OUTPUTS FROM A VARIETY OF SENSORS
- 85 to 250 VAC and 9 to 32 VDC POWERED VERSIONS AVAILABLE
- LOW FREQUENCY CUT-OUT AND OVERRANGE INDICATION
- 3-WAY ELECTRICAL ISOLATION (POWER/INPUT/OUTPUT)
- INPUT AND OUTPUT INDICATION LEDs

UL Recognized Component,
File # E137808

DESCRIPTION

The Model IFMA accepts a frequency input, and outputs an analog voltage or current in proportion to the input frequency, with 0.1% accuracy. The full scale input frequency can be set to any value from 1 Hz to 25 KHz, either with a frequency source, or digitally with the on-board rotary switch and push-button.

The IFMA utilizes a seven position DIP switch, a rotary switch, a push-button and two indication LEDs to accomplish input circuit configuration, operational parameter set-up, and Input/Output indication. The input circuitry is DIP switch selectable for a variety of sources.

The indication LEDs are used during normal operation to display the input and output status of the IFMA. These LEDs are also used to provide visual feedback to the user of the existing parameter settings during parameter set-up.

The IFMA operates in one of four output modes. The programmable minimum and maximum response times provide optimal response at any input frequency.

The unit is equipped with a universal mounting foot for attachment to standard DIN style mounting rails, including top hat profile rail according to EN 50 022 - 35 x 7.5 and 35 x 15, and G profile rail according to EN 50 035 - G 32.

SAFETY SUMMARY

All safety related regulations, local codes and instructions that appear in the manual or on equipment must be observed to ensure personal safety and to prevent damage to either the instrument or equipment connected to it. If equipment is used in a manner not specified by the manufacturer, the protection provided by the equipment may be impaired.

SPECIFICATIONS

- POWER:**
AC Operation: 85 to 250 VAC, 48 to 62 Hz; 6.5 VA
DC Operation: 9 to 32 VDC; 2.5 W
Power Up Current: $I_p = 600$ mA for 50 msec. max.
- SENSOR POWER:** (AC version only) +12 VDC $\pm 25\%$ @ 60 mA max.
- OPERATING FREQUENCY RANGE:**
 From 0 Hz to 25 KHz; user selectable.
- SIGNAL INPUT:** DIP switch selectable to accept signals from a variety of sources, including switch contacts, outputs from CMOS or TTL circuits, magnetic pickups, and all standard RLC sensors.
Current Sourcing: Internal 1 K Ω pull-down resistor for sensors with current sourcing output. (Max. sensor output current = 24 mA @ 24 V output.)
Current Sinking: Internal 3.9 K Ω pull-up resistor for sensors with current sinking output. (Max. sensor current = 3 mA.)

Low Bias: Input trigger levels $V_{IL} = 0.25$ V, $V_{IH} = 0.75$ V; for increased sensitivity when used with magnetic pickups.

Hi Bias: Input trigger levels $V_{IL} = 2.5$ V, $V_{IH} = 3.0$ V; for logic level signals.

Max. Input Signal: ± 90 V; 2.75 mA max. (With both Current Sourcing and Current Sinking resistors switched off.)

- SIGNAL VOLTAGE OUTPUT (Selectable):**
 0 to 5 VDC @ 10 mA max.
 0 to 10 VDC @ 10 mA max.
- SIGNAL CURRENT OUTPUT (Selectable):**
 0 to 20 mA @ 10 VDC min.
 4 to 20 mA @ 10 VDC min.
- OUTPUT COMPLIANCE:**
Voltage: 10 V across a min. 1K Ω load (10 mA). Factory calibrated for loads greater than 1 M Ω .
Current: 20 mA through a max. 500 Ω load (10 VDC).
- ACCURACY:** $\pm 0.1\%$ of full scale range ($\pm 0.2\%$ for 0 to 5 VDC range).
- RESOLUTION:**
 Voltage : 3.5 mV min.
 Current: 5 μ A min.

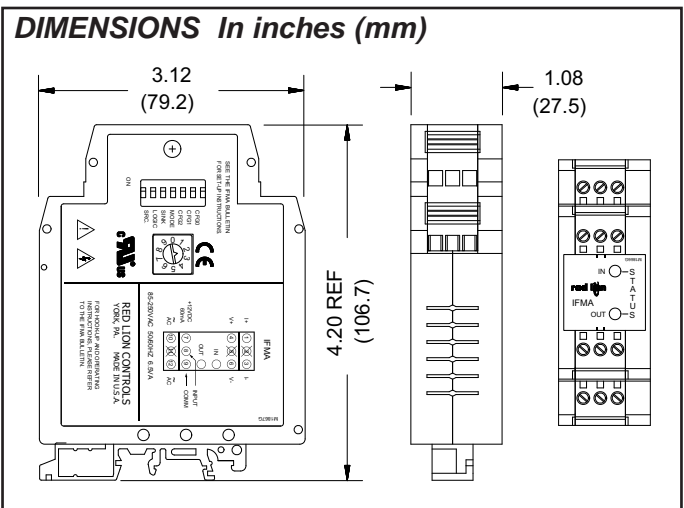

ORDERING INFORMATION

MODEL NO.	DESCRIPTION	PART NUMBERS FOR AVAILABLE SUPPLY VOLTAGES	
		9 to 32 VDC	85 to 250 VAC
IFMA	Pulse Rate to Analog Converter	IFMA0035	IFMA0065

For more information on Pricing, Enclosures & Panel Mount Kits refer to the RLC Catalog or contact your local RLC distributor.

CAUTION: Risk of Danger.
 Read complete instructions prior to installation and operation of the unit.

CAUTION: Risk of electric shock.

SPECIFICATIONS (Cont'd)

10. **RESPONSE TIME:** 5 msec +1 period to 10 sec +1 period; user selectable
 11. **INPUT IMPEDANCE:** 33 K Ω min. with the sink and source DIP switches in the OFF position (See Block Diagram).
 12. **INPUT AND POWER CONNECTIONS:** Screw in terminal blocks.
 13. **ISOLATION BREAKDOWN VOLTAGE (Dielectric Withstand):** 2200 V between power & input, and power & output; 500 V between input & output for 1 minute.

14. CERTIFICATIONS AND COMPLIANCES:

SAFETY

UL Recognized Component, File #E137808, UL508, CSA C22.2 No. 14 Recognized to U.S. and Canadian requirements under the Component Recognition Program of Underwriters Laboratories, Inc.
 IECCE CB Scheme Test Report # 97ME50135-042297
 Issued by Underwriters Laboratories, Inc.
 IEC 61010-1, EN 61010-1: Safety requirements for electrical equipment for measurement, control, and laboratory use, Part 1.

EMC EMISSIONS:

Meets EN 50081-2: Industrial Environment.
 CISPR 11 Radiated and conducted emissions

EMC IMMUNITY:

Meets EN 50082-2: Industrial Environment.
 ENV 50140 - Radio-frequency radiated electromagnetic field 1
 ENV 50141 - Radio-frequency conducted electromagnetic field
 EN 61000-4-2 - Electrostatic discharge (ESD) 2

EN 61000-4-4 - Electrical fast transient/burst (EFT)

EN 61000-4-8 - Power frequency magnetic field

Notes:

- For operation without loss of performance:
 Unit is mounted on a rail in a metal enclosure (Buckeye SM7013-0 or equivalent) and I/O cables are routed in metal conduit connected to earth ground.
- This device was designed for installation in an enclosure. To avoid electrostatic discharge, precautions should be taken when the device is mounted outside an enclosure. When working in an enclosure (ex. making adjustments, setting switches, etc.) typical anti-static precautions should be observed before touching the unit.
 Refer to the EMC Installation Guidelines section of this bulletin for additional information.

15. ENVIRONMENTAL CONDITIONS:

Operating Temperature: 0 to 50°C

Storage Temperature: -40 to 80°C

Operating and Storage Humidity: 85% max. (non-condensing) from 0°C to 50°C.

Vibration according to IEC 68-2-6: Operational 5 to 150 Hz, in X, Y, Z direction for 1.5 hours, 3 g's.

Shock according to IEC 68-2-27: Operational 30 g's, 11 msec in 3 directions.

Altitude: Up to 2000 meters

16. **CONSTRUCTION:** Case body is black, high impact plastic. Installation Category II, Pollution Degree 2

17. **WEIGHT:** 6 oz. (0.17 Kg)

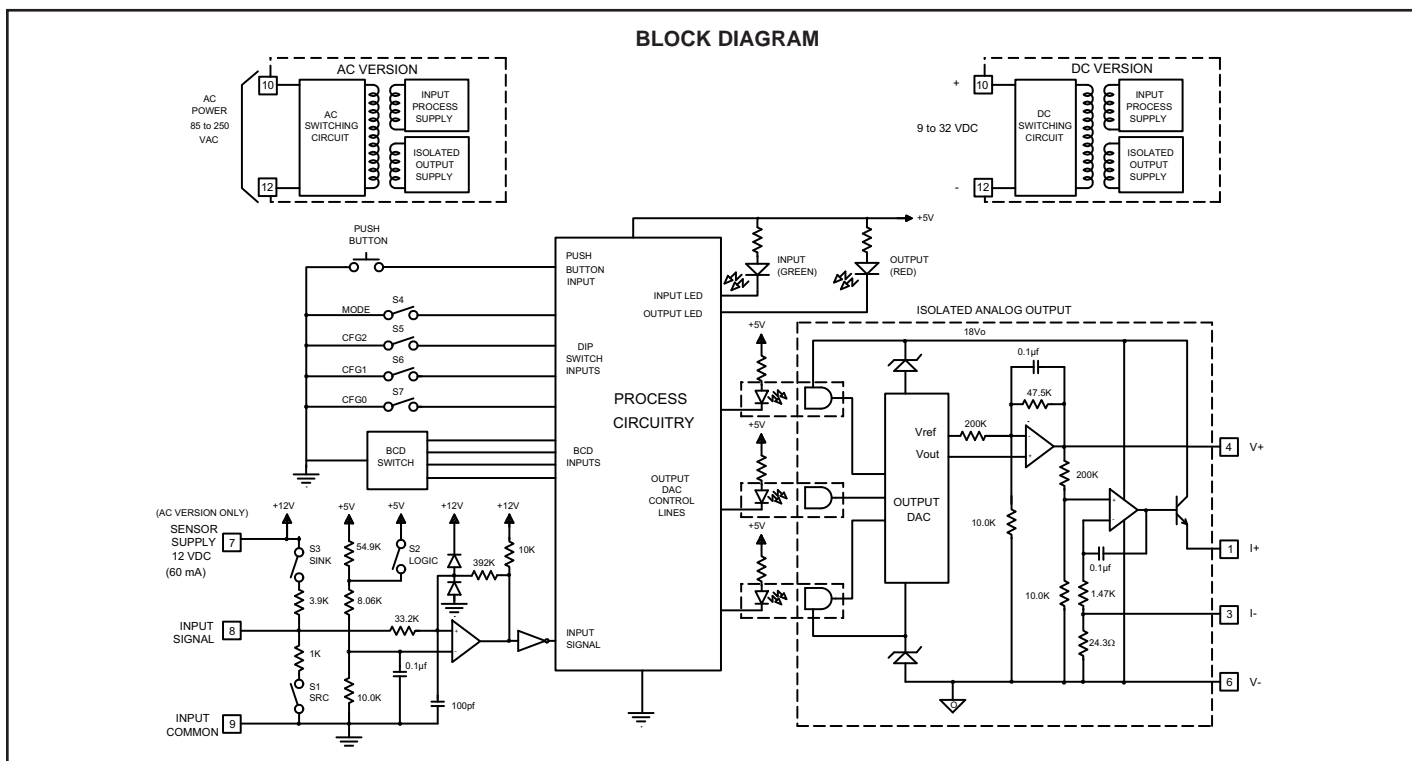

OVERVIEW

The Model IFMA continuously monitors a frequency input and outputs a voltage or current signal in proportion to the input signal. The output is accurate to $\pm 0.1\%$ of full scale for Operating Modes 2, 3, and 4. Operating Mode 1 is accurate to $\pm 0.2\%$ of full scale. The green Input LED blinks at the rate of the input frequency. At about 100 Hz, the Input LED will appear to be solid on. At very low frequencies, the Input LED blinks slowly and may also appear to be solid on. A loss of signal may also cause the Input LED to remain on, depending on the DIP switch set-up. In this case, the red LED also turns on.

The Minimum Response Time parameter sets the minimum update time of the output. The actual response time is the Minimum Response Time plus up to one full period of the input signal. The IFMA counts the negative edges occurring during the update time period, and computes the average frequency value for that time. This action filters out any high frequency jitter that may be present in the input signal. The longer the Minimum Response Time, the more filtering occurs.

The Maximum Response Time parameter sets the Low Frequency Cut-out response time for the unit. If a new edge is not detected within the time specified by the Maximum Response Time setting, the unit sets the output to the existing Low Frequency Cut-out Value setting depending on the selected range and calibration setting.

The unit also indicates Low Frequency Cut-out by turning ON the output LED. The Maximum Response Time can be set shorter than the Minimum Response Time. In this case, as long as the input signal period is shorter than the Maximum Response Time, the unit continues to indicate the input frequency at its output. But, if the input period at any time exceeds the Maximum Response Time, the unit immediately takes the output to the Low Frequency Cut-out Value, regardless of the Minimum Response Time setting.

The IFMA is calibrated at the factory for all of the selected ranges. However, the user can adjust the minimum calibration to any value less than the Full Scale value, and the Full Scale value to any value greater than the minimum value. If the minimum and full scale values are brought closer together, the accuracy of the unit decreases proportionate to the decreased range of the unit (See Calibration).

EMC INSTALLATION GUIDELINES

Although this unit is designed with a high degree of immunity to ElectroMagnetic Interference (EMI), proper installation and wiring methods must be followed to ensure compatibility in each application. The type of the electrical noise, source or coupling method into the unit may be different for various installations. The unit becomes more immune to EMI with fewer I/O connections. Cable length, routing, and shield termination are very important and can mean the difference between a successful installation or troublesome installation.

Listed below are some EMC guidelines for successful installation in an industrial environment.

1. Use shielded (screened) cables for all Signal and Control inputs. The shield (screen) pigtail connection should be made as short as possible. The connection point for the shield depends somewhat upon the application. Listed below are the recommended methods of connecting the shield, in order of their effectiveness.
 - a. Connect the shield only at the rail where the unit is mounted to earth ground (protective earth).
 - b. Connect the shield to earth ground at both ends of the cable, usually when the noise source frequency is above 1 MHz.
 - c. Connect the shield to common of the unit and leave the other end of the shield unconnected and insulated from earth ground.
2. Never run Signal or Control cables in the same conduit or raceway with AC power lines, conductors feeding motors, solenoids, SCR controls, and heaters, etc. The cables should be run in metal conduit that is properly grounded. This is especially useful in applications where cable runs are long and portable two-way radios are used in close proximity or if the installation is near a commercial radio transmitter.
3. Signal or Control cables within an enclosure should be routed as far away as possible from contactors, control relays, transformers, and other noisy components.
4. In extremely high EMI environments, the use of external EMI suppression devices, such as ferrite suppression cores, is effective. Install them on Signal and Control cables as close to the unit as possible. Loop the cable through the core several times or use multiple cores on each cable for additional protection. Install line filters on the power input cable to the unit to suppress power line interference. Install them near the power entry point of the enclosure. The following EMI suppression devices (or equivalent) are recommended:

Ferrite Suppression Cores for signal and control cables:

Fair-Rite # 0443167251 (RLC #FCOR0000)

TDK # ZCAT3035-1330A

Steward #28B2029-0A0

Line Filters for input power cables:

Schaffner # FN610-1/07 (RLC #LFIL0000)

Schaffner # FN670-1.8/07

Corcom #1VR3

Note: Reference manufacturer's instructions when installing a line filter.

5. Long cable runs are more susceptible to EMI pickup than short cable runs. Therefore, keep cable runs as short as possible.

WIRING CONNECTIONS

All conductors should meet voltage and current ratings for each terminal. Also cabling should conform to appropriate standards of good installation, local codes and regulations. It is recommended that power supplied to the unit (AC or DC) be protected by a fuse or circuit breaker.

POWER AND OUTPUT CONNECTIONS

AC Power

Primary AC Power is connected to terminals 10 and 12 (labeled AC). For best results, the AC Power should be relatively "clean" and within the specified variation limits. Drawing power from heavily loaded circuits or from circuits that also power loads that cycle on and off, should be avoided.

DC Power

The DC power is connected to terminals 10 and 12. The DC plus (+) power is connected to terminal 10 and the minus (-) is connected to terminal 12.

It is recommended that separate supplies be used for sensor power and unit power. Using the same supply for both will negate isolation between input and power.

Current Output

When using Operating Mode 3 or 4, the output device is connected to terminals 1(I+) and 3 (I-).

Voltage Output

When using Operating Mode 1 or 2, the output device is connected to terminals 4 (V+) and 6 (V-).

Note: Although signals are present at voltage and current outputs at the same time, only the selected mode is in calibration at any one time.

Example: Operating Mode 2 is selected. The voltage level present at the voltage terminals is in calibration, but the signal appearing at the current terminals does not conform to either of the current output modes.

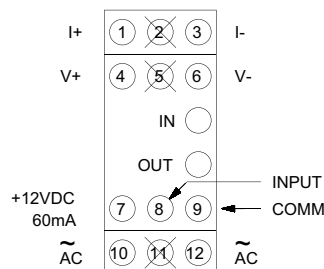

Authorised Distributor

ADITECH ICT PVT. LTD.

803,sigma IT park, plat no 203/204 Rabale, TTC Industrial area, Thane-Belapur road, Rabale-400701

Tel:+91 9819884527 Email: sales@aditech.in Website: www.aditech.in

INPUT CIRCUITS, SENSOR CONNECTIONS AND CONFIGURATION SWITCH SET-UP

The Model IFMA uses a comparator amplifier connected as a Schmidt trigger circuit to convert the input wave form into the pulse form required for proper circuit operation. Three set-up switches are used to configure the input circuit to accept signals from a wide variety of sources, as follows:

S1 - ON: Connects a 1 KΩ pull-down resistor for sensors with sourcing outputs. (Maximum sensor output current is 24 mA @ 24 VDC output.)

S2 - ON: For logic level signals. Sets the input bias levels to $V_{IL} = 2.5\text{ V}$, $V_{IH} = 3.0\text{ V}$.

OFF: For increased sensitivity when used with magnetic pickups. Sets the input bias levels to $V_{IL} = 0.25\text{ V}$, $V_{IH} = 0.75\text{ V}$.

S3 - ON: Connects a 3.9 KΩ pull-up resistor for sensors with current sinking output. (Max. sensor current = 3 mA.)

CONNECTIONS & CONFIGURATION SWITCH SET-UP FOR VARIOUS SENSOR OUTPUTS

Note: Separate power supplies must be used for sensor power and input power to maintain the isolation breakdown voltage specification. If isolation between power and input is not needed, then a single supply can be used for both unit and sensor power.

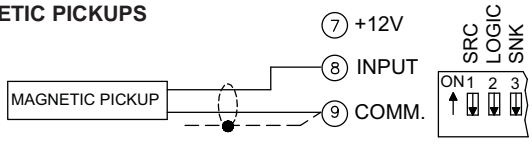
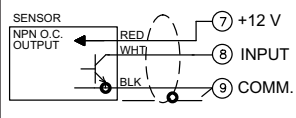
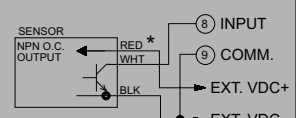
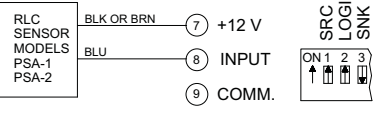
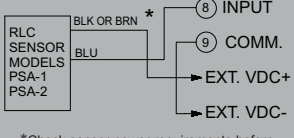
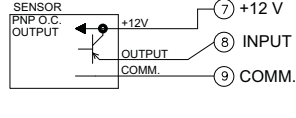
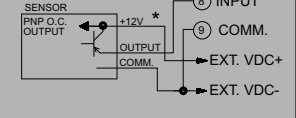
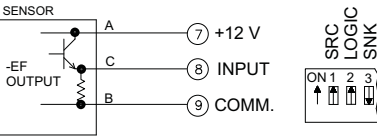
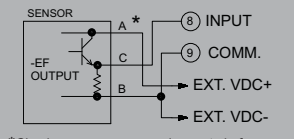
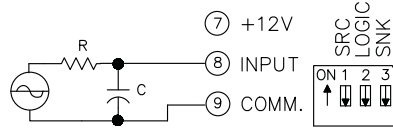
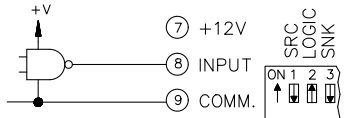
<p>MAGNETIC PICKUPS</p>  <p>RECOMMENDED RULES FOR MAGNETIC PICKUP CONNECTIONS</p> <p>1. Connect the shield to the common Terminal "9" at the input of the IFMA. DO NOT connect the shield at the pickup end. Leave the shield "open" at the pickup and insulate the exposed shield to prevent electrical contact with the frame or case. (Shielded cable, supplied on some RLC magnetic pickups, has open shield on pickup end.)</p>	<p>SENSORS WITH CURRENT SINK OUTPUT (NPN O.C.)</p> <div style="display: flex; justify-content: space-between;"> <div style="width: 45%;"> <p>AC VERSION</p>  <p>RLC SENSOR MODELS: ASTC, LMPC, PSA, ZCG, ZFG, ZGG, ZHG, ZBG</p> </div> <div style="width: 45%; background-color: #f0f0f0; padding: 5px;"> <p>DC VERSION</p>  <p>*Check sensor power requirements before wiring.</p> </div> </div>
<p>2-WIRE PROXIMITY SENSORS</p> <div style="display: flex; justify-content: space-between;"> <div style="width: 45%;"> <p>AC VERSION</p>  <p>RLC SENSOR MODELS PSA-1 PSA-2</p> </div> <div style="width: 45%; background-color: #f0f0f0; padding: 5px;"> <p>DC VERSION</p>  <p>*Check sensor power requirements before wiring.</p> </div> </div>	<p>SENSORS WITH CURRENT SOURCE OUTPUT (PNP O.C.)</p> <div style="display: flex; justify-content: space-between;"> <div style="width: 45%;"> <p>AC VERSION</p>  </div> <div style="width: 45%; background-color: #f0f0f0; padding: 5px;"> <p>DC VERSION</p>  <p>*Check sensor power requirements before wiring.</p> </div> </div>
<p>OLDER STYLE RLC SENSORS WITH -EF OUTPUT</p> <div style="display: flex; justify-content: space-between;"> <div style="width: 45%;"> <p>AC VERSION</p>  </div> <div style="width: 45%; background-color: #f0f0f0; padding: 5px;"> <p>DC VERSION</p>  <p>*Check sensor power requirements before wiring.</p> </div> </div>	<p>A.C. INPUTS FROM INVERTERS, A.C. TACHOMETERS, GENERATORS, ETC.</p>  <p>R - RESISTOR TO LIMIT INPUT CURRENT TO 5 mA PEAK C - FILTER CAP REQUIRED WHEN INPUT A.C. HAS "RINGING" CHARACTERISTICS AS WITH INVERTERS</p> <p>A.C. POWER SOURCES EXCEEDING 50V OUTPUT SHOULD BE COUPLED WITH AN ISOLATION TRANSFORMER</p>
<p>INPUT FROM CMOS OR TTL</p> 	

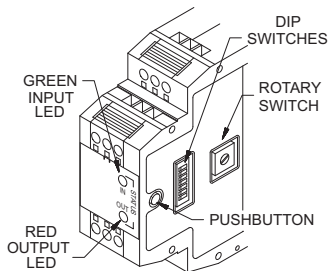

CONFIGURING THE IFMA

To begin set-up, place DIP switch 4 to the on (up) position. DIP switches 5, 6, and 7 access unit configuration settings. Upon entry to a set-up parameter, the Input LED blinks the current numerical value of a setting at a 1 Hz rate. A setting of "1" is indicated by one blink (½ sec on, ½ sec off), through a setting of "9", which is indicated by nine blinks. A setting of "0" is indicated by a single short flash (40 msec on, 1 sec off). The decimal point position is the last number blinked. After the entire value is indicated, the IFMA pauses two seconds and repeats the value.

During entry of a new value, if the Mode switch (S4) or any of the CFG DIP switch positions are changed before the push button is pressed, the IFMA aborts the entry process and retains the previous setting.

DIP SWITCH	DESCRIPTION	SECTION
	Operating Mode	(1.0)
	Input Range Setting Using an Input Signal or Frequency Generator	(2.0)
	Input Range Setting Using the Rotary Switch	(3.0)
	Minimum Response Time	(4.0)
	Maximum Response Time (Low Frequency Cut-Out Setting)	(5.0)
	Analog Output Minimum Value	(6.0)
	Analog Output Full Scale Value	(6.0)

Note: To return to normal operation, place DIP switch 4 in the down (RUN) position.

() Indicates Configuration Section

OUTPUT INDICATION

Over range on the output : The Output LED (red) turns on and the Output is “clamped” at the maximum level.

Low Frequency Cut-Out : The Output LED (red) turns on to indicate the input frequency is below the Zero Frequency setting.

Invalid Entry during Set-up : The Input LED (green) and the Output LED (red) alternately blink until a valid entry is made.

FACTORY SETTINGS		
Parameter	Setting	Value
Operating Mode	4	4 to 20 mA
Input Range	10.000	10 KHz
Minimum Response	0	5 msec
Maximum Response	0	1024 times Input Range Period (102 msec, 9.8 Hz)

1.0 Operating Mode (Analog Output)

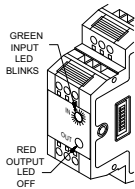

Step 1.2

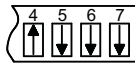

Step 1.1

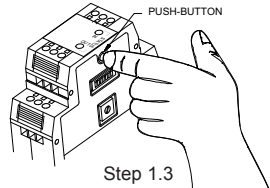

Step 1.3

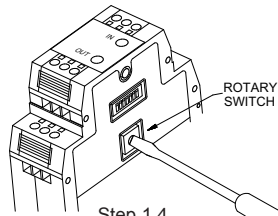

Step 1.4



- 1.1 Place DIP switch 4 to the ON (up) position and DIP switches 5, 6, and 7 as shown.
- 1.2 Green input LED blinks the Setting corresponding to the Operating Mode shown below, pauses and repeats the value.

Setting	Operating Mode
1	0 to 5 VDC
2	0 to 10 VDC
3	0 to 20 mA
4	4 to 20 mA

- ◆ *Factory calibration values are restored when the Operating Mode is changed.*
- ◆ *If existing operating mode setting is your desired requirement, this section is complete*. Otherwise, continue with Step 1.3.*

- 1.3 Press the push-button. The Green input LED blinks rapidly to indicate the Operating mode setting is now accessed.
- 1.4 Turn the rotary switch to the selected numerical value for the output desired (see the list in Step 1.2).
- 1.5 Press the push-button. The Green input LED blinks value entered, pauses, and repeats the new Operation setting.

- ◆ *If the new Operating mode setting is acceptable, this section is complete*.*
- ◆ *If the new Operating mode setting is not the desired setting, repeat from Step 1.3.*
- ◆ *If the Red output LED blinks, the rotary switch numerical value is invalid. Repeat Steps 1.4 and 1.5.*

* Section complete; place DIP switch 4 to the Down position for normal operation, or change DIP switches 5, 6, and 7 for the next Configuration Section.

2.0 On-Line Input Range Setting Using Actual Input Signal Or Frequency Generator

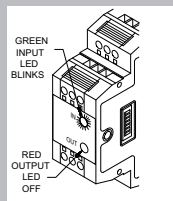

Step 2.2

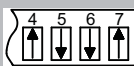

Step 2.1

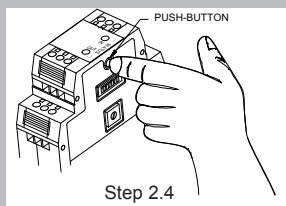

Step 2.4

- 2.1 Place DIP switch 4 to the ON position and DIP switches 5, 6, and 7 as shown.
- 2.2 The Green input LED blinks the existing Input Range setting as shown in the examples below. Six full digits of numerical information blink with a short pause between digits and a longer pause before repeating. The first five digits are the existing input range setting of the frequency magnitude. The sixth digit is the frequency resolution (the number of digits to the right of the decimal point).

Factory Setting Example

1 blink	1	
2 sec pause		
single flash	0	
2 sec pause		
single flash	0	Frequency
2 sec pause		setting
single flash	0	
2 sec pause		
single flash	0	
2 sec pause		
single flash	0	Resolution
2 sec pause		
4 sec pause		

Frequency	Resolution
1 0 0 0 0 0	0

Result: 10.000 KHz

Additional Example:

2 blinks	2	
2 sec pause		
5 blinks	5	
2 sec pause		
single flash	0	Frequency
2 sec pause		setting
5 blinks	5	
2 sec pause		
single flash	0	
2 sec pause		
2 blinks	2	Resolution
4 sec pause		

Frequency	Resolution
2 5 0 5 0 0	2

Result: 250.50 Hz

- ◆ *If the existing Input Range setting is your desired requirement, this section is complete*. Otherwise, continue with Step 2.3.*

- 2.3 Apply the maximum input signal.
- 2.4 Press the push-button. The Green input LED blinks rapidly. The acquisition process takes two seconds plus one period of the input signal.

- ◆ *If the new input range setting is valid, the Green input LED turns on solid. Continue to Step 2.5.*
- ◆ *If Red output LED blinks, the new input range setting is invalid, outside the acceptable 1 Hz to 25 KHz range. Repeat Steps 2.3 and 2.4.*

- 2.5 Press the push-button. The Green input LED blinks the new Input Range setting. This section is complete*. Verify the Input Range setting as shown in Step 2.2.

* Section complete; place DIP switch 4 to the Down position for normal operation, or change DIP switches 5, 6, and 7 for the next Configuration Section.

PREFERRED METHOD

Authorised Distributor **ADITECH ICT PVT. LTD.**

803,sigma IT park, plat no 203/204 Rabale, TTC Industrial area, Thane-Belapur road, Rabale-400701

Tel:+91 9819884527 Email: sales@aditech.in Website: www.aditech.in

3.0 Input Range Setting Using The Rotary Switch



Step 3.1

Step 3.2

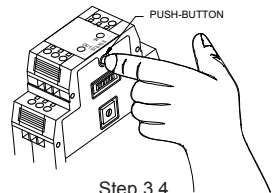

Step 3.4

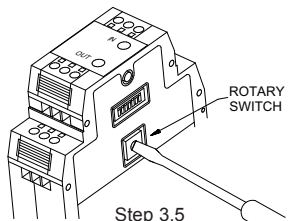

Step 3.5



Setting '2' Selected

ALTERNATIVE METHOD IF INPUT SIGNAL IS NOT AVAILABLE

- 3.1 Place DIP switch 4 to the ON(up) position and DIP switches 5, 6, and 7 as shown.
- 3.2 The Green input LED blinks the existing Input Range setting, pauses and repeats. Six full digits of numerical information blink with a short pause between digits and a longer pause at the end, before repeating. The first five digits are the existing input range setting magnitude. The sixth digit is the frequency resolution (the number of digits to the right of the decimal point).

◆ *If the existing Input Range setting is your desired requirement, this section is complete*. Otherwise, continue with Step 3.3.*

- 3.3 Determine the Input Range frequency and record in the space provided below.

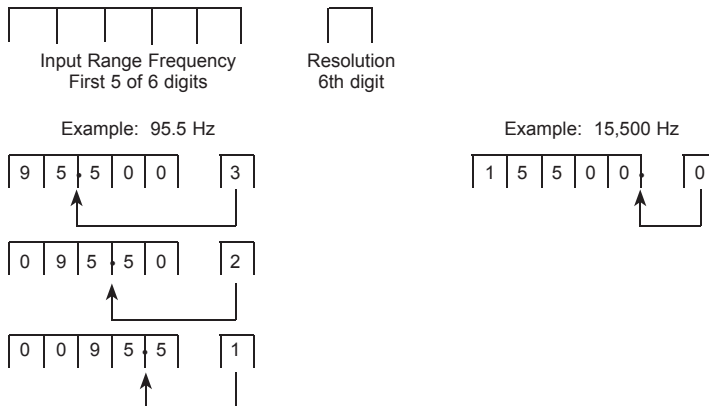

- 3.4 Press the push-button. The Green input LED blinks rapidly. Input Range setting is now accessed.
- 3.5 Turn the rotary switch to the first selected numerical value. Press the push-button. The Green input LED continues to blink rapidly. First of six digits is entered.
- 3.6 Turn the rotary switch to the second selected numerical value. Press the push-button. The Green input LED continues to blink rapidly. Second of six digits is entered.
- 3.7 Repeat Step 3.6 three more times, then go to Step 3.8. This enters a total of five of the required six numerical digits.
- 3.8 Turn the rotary switch to the selected numerical value for resolution requirement. Press the push-button. The Green input LED blinks the new Input Range setting (as described in Step 2.2), pauses, and repeats the value.

- ◆ *If the new Input Range setting is acceptable, this section is complete*.*
- ◆ *If the new Input Range setting is not the desired setting, repeat Steps 3.4, through 3.8.*
- ◆ *If the Red output LED blinks, the numerical value entered is invalid. Repeat Steps 3.3 through 3.8.*

* Section complete; place DIP switch 4 to the Down position for normal operation, or change DIP switches 5, 6, and 7 for the next Configuration Section.

4.0 Minimum Response Time Setting



Step 4.1

Step 4.2

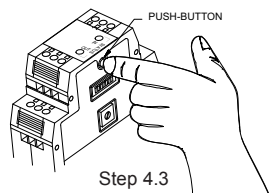

Step 4.3

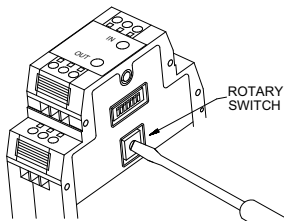

Step 4.4



Setting '2' Selected

- 4.1 Position DIP switch 4 to the ON(up) position and DIP switches 5, 6, and 7 as shown.
- 4.2 The Green input LED blinks the corresponding Minimum Response Time Setting (see following list), pauses and repeats.

Setting	Time
0	5 msec
1	10 msec
2	20 msec
3	50 msec
4	100 msec

Setting	Time
5	200 msec
6	500 msec
7	1 sec
8	5 sec (not valid for input range > 3906 Hz)
9	10 sec (not valid for input range > 3906 Hz)

◆ *If the existing Minimum Response Time setting is your desired requirement, this section is complete*. Otherwise, continue with Step 4.3.*

- 4.3 Press the push-button. The Green input LED blinks rapidly. Minimum Response Time setting is now accessed.
- 4.4 Turn the rotary switch to the selected numerical value for Minimum Response Time desired (see list in Step 4.2).
- 4.5 Press the push-button. The Green input LED blinks the value entered, pauses, and repeats the new Minimum Response Time setting.

- ◆ *If the new Minimum Response Time setting is acceptable, this section is complete*.*
- ◆ *If the new Minimum Response Time setting is not acceptable, repeat from step 4.3.*
- ◆ *If the Red output LED blinks, the rotary switch numerical value is invalid. Repeat Steps 4.4 and 4.5.*

* Section complete; place DIP switch 4 to the Down position for normal operation, or change DIP switches 5, 6, and 7 for the next Configuration Section.

5.0 Maximum Response Time Setting (Low Frequency Cut-Out Setting)

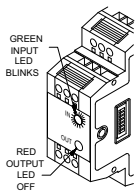

Step 5.2

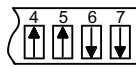

Step 5.1

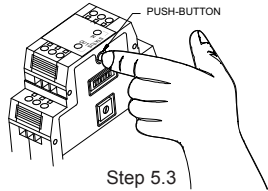

Step 5.3

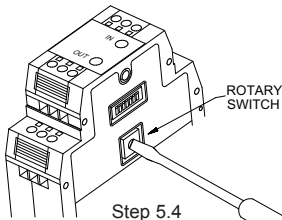

Step 5.4



Setting '9'
Selected

- 5.1 Place DIP switch 4 to the ON (up) position and DIP switches 5, 6, and 7 as shown.
5.2 The Green input LED blinks the corresponding Maximum Response Time Setting (see following list), pauses and repeats.

Setting	Time
0	1024 times Input Range period (40 msec min., 10 sec max.)
1	10 msec (100 Hz)
2	20 msec (50 Hz)
3	50 msec (20 Hz)
4	100 msec (10 Hz)

Setting	Time
5	200 msec (5 Hz)
6	500 msec (2 Hz)
7	1 sec (1 Hz)
8	5 sec (.2 Hz)
9	10 sec (.1 Hz)

◆ *If the existing Maximum Response Time setting is your desired requirement, this section is complete*. Otherwise, continue with Step 5.3.*

5.3 Press the push-button. The Green input LED blinks rapidly. Maximum Response Time setting is now accessed.

5.4 Turn the rotary switch to the selected numerical value for Maximum Response Time desired. (see list in Step 5.2)

5.5 Press the push-button. The Green input LED blinks the value entered, pauses, and repeats the new Maximum Response Time setting.

◆ *If the new Maximum Response Time setting is acceptable, this section is complete*.*

◆ *If the new Maximum Response Time setting is not acceptable, repeat from Step 5.3.*

◆ *If the Red output LED blinks, the rotary switch numerical value is invalid. Repeat Steps 5.4 and 5.5.*

* Section complete; place DIP switch 4 to the Down position for normal operation, or change DIP switches 5, 6, and 7 for the next Configuration Section.

6.0 Calibration

The IFMA is factory calibrated for all operating modes. These settings are permanently stored in the unit's configuration memory. The IFMA automatically selects the proper calibration setting for the selected Operation mode.

The Minimum and Full Scale output values established at the factory can be changed using the calibration routines. The Minimum output value can be adjusted to any value less than the Full Scale output value, and the Full Scale value can be adjusted to any value greater than the Minimum value.

Changing the factory calibration settings does affect the accuracy of the unit. Specified accuracy for modes 2, 3, and 4 holds until the factory calibration range has been halved. This does not apply to mode 1, since it already uses only half of the IFMA's output range. When increasing the output range, the new calibration settings can not exceed the factory Full Scale value by more than 10%. The 0 to 5 VDC range can be doubled.

The IFMA can store user calibration settings for only one mode at a time. If calibration is changed for one operating mode, and the user then selects a different operating mode, the unit reverts to factory calibration settings. Calibration steps can be combined (added) to obtain a total calibration change. This is done by repeated push-button entries of the same value, or different values, before saving the change. The calibration steps as shown in the table at right are approximations. A current or volt meter should be connected to the appropriate output pins to verify the actual calibration setting.

Approximate Calibration Increments

ROTARY SWITCH	VOLTAGE	CURRENT
1	3 mV	5 μ A
2	5 mV	10 μ A
3	10 mV	25 μ A
4	25 mV	50 μ A
5	50 mV	100 μ A
6	100 mV	200 μ A
7	200 mV	400 μ A
8	400 mV	800 μ A

Calibration Direction

The default direction for calibration changes is up (increasing values) on entry to either calibration routine. This direction can be toggled from within the routine with the following steps:

1. Enter the calibration routine you wish to change (Minimum or Full Scale).
2. Press the push-button. The Green input LED blinks rapidly.
3. Turn the rotary switch to position 9. Press the push-button.
4. The Output LED indicates the direction of calibration:

OFF = Increasing Value
ON = Decreasing Value

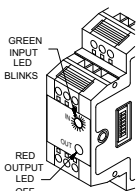

Step 6.2

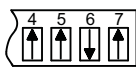

Step 6.2

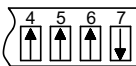

Step 6.2

Analog Output Minimum Value

Analog Output Full Scale Value

6.1 Connect a current or voltmeter of appropriate accuracy to the desired output pins (voltage or current)

6.2 Place DIP switch 4 to the ON position and DIP switches 5, 6, and 7 as shown. The Green input LED blinks slowly.

6.0 Calibration (Cont'd)

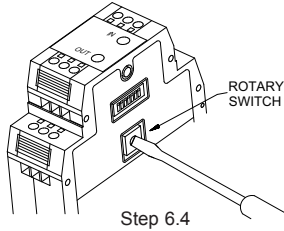
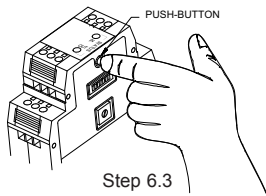

6.3 Press the push-button to enable the rotary switch. The Green input LED now blinks at a faster rate, indicating that calibration values are accessible.

6.4 Turn rotary switch to appropriate numerical setting for calibration (see list in Step 6.0), while monitoring the output signal. Press the push-button. Calibration is raised or lowered by this approximate value, depending on calibration direction.

- ◆ If this setting meets your requirements, go to step 6.5. If more calibration is required, repeat step 6.4 until the calibration meets your requirements.
- ◆ If you overshoot your desired value, reverse calibration direction as shown in 6.0 and continue calibration until the value meets your requirements.

6.5 Turn the rotary switch to 0 and press the push-button. This saves the new user calibration setting.

- ◆ If you want to return to factory calibration, exit Calibration and then re-enter. Turn rotary switch to 0 and press push-button twice. This reloads the factory calibration setting for the selected mode of operation.
- ◆ When calibrating the Minimum output value, if the red output LED blinks while in the down direction, the requested calibration setting is beyond the output's absolute minimum value. The calibration setting is held at the absolute minimum value. Reverse calibration direction and repeat from step 6.4.
- ◆ When calibrating Full Scale, if the red output LED blinks while in the up direction, the requested calibration setting is beyond the output's absolute maximum value. The calibration setting is held at the maximum value. Reverse calibration direction and repeat from step 6.4.
- ◆ If an attempt is made to calibrate the Full Scale value lower than the Minimum value, or conversely, the Minimum value higher than the Full Scale value, the red output LED blinks, and the IFMA sets the two values equal. Reverse calibration direction and repeat from step 6.4.

Calibration Example (Scaling):

A customer using the 0 to 10 VDC output range of the IFMA wants the Minimum value to be at 1 VDC. To do this, connect a voltmeter to the output of the IFMA to monitor the output voltage. Access Configuration Mode by placing DIP switch 4 to the ON (up) position. Access Analog Output Minimum value by placing DIP switches 5 and 7 up, and DIP switch 6 down. Press the push-button to enable changes to the calibration value. Turn the rotary switch to position 8 and press the push-button. The voltmeter should reflect an increase of about 400 mV. With the rotary switch still at position 8, press the push-button again. The voltmeter should now read approximately 800 mV. Turn the rotary switch to a position lower than 8 to effect a smaller change in calibration. Continue adjusting the rotary switch and pressing the push-button until 1 VDC is displayed on the voltmeter. Turn the rotary switch to position 0 and press the push-button. This action saves the new calibration setting for the Minimum value.

TROUBLESHOOTING

For further technical assistance, contact technical support at the appropriate company numbers listed.

INSTALLATION

The unit is equipped with a universal mounting foot for attachment to standard DIN style mounting rails, including G profile rail according to EN50035 - G32, and top hat (T) profile rail according to EN50022 - 35 x 7.5 and 35 x 15. The unit should be installed in a location that does not exceed the maximum operating temperature and provides good air circulation. Placing the unit near devices that generate excessive heat should be avoided.

G Rail Installation

To install the IFMA on a "G" style DIN rail, angle the module so that the upper groove of the "foot" catches under the lip of the top rail. Push the module toward the rail until it snaps into place. To remove a module from the rail, push up on the bottom of the module while pulling out and away from the rail.

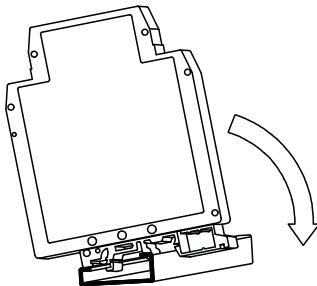

T Rail Installation

To install the IFMA on a "T" style rail, angle the module so that the top groove of the "foot" is located over the lip of the top rail. Push the module toward the rail until it snaps into place. To remove a module from the rail, insert a screwdriver into the slot on the bottom of the "foot", and pry upwards on the module until it releases from the rail.

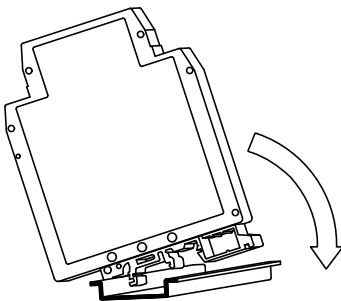

APPLICATION

A customer needs a unit to output a signal to a chart recorder for a flow rate system. There is an existing APLR rate indicator receiving an input from a PSAC inductive proximity sensor. The IFMA Frequency to Analog Converter is connected in parallel with the APLR to output the signal to the chart recorder.

The flow rate is measured in gal/min. and needs to be converted to a 0 to 10 VDC signal. The Operating Mode of the IFMA is set for a 0 to 10 VDC output signal. The PSAC measures 48 pulses/gal. with a maximum flow rate of 525 gal/min. The Maximum Response Time is set to setting '9' (10 sec). The chart recorder will record 0 VDC at 0.125 gal/min, and 10 VDC at 525 gal/min.

The Input Range can be set one of two ways. By entering the calculated maximum frequency with the rotary switch, or by applying the maximum frequency signal of the process to the input of the IFMA. To set the input with the rotary switch, first determine the maximum frequency generated by the maximum output of the sensor using the following formula:

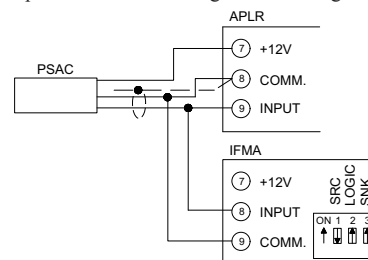

$$\text{Max. Freq.} = \frac{\text{unit/measure} \times \text{pulses/unit}}{\text{seconds/measure}}$$

$$\text{Max. Freq.} = \frac{525 \text{ GPM} \times 48 \text{ PPG}}{60 \text{ sec.}} = 420 \text{ Hz}$$

Set the Input Range with the rotary switch to 420 Hz.